

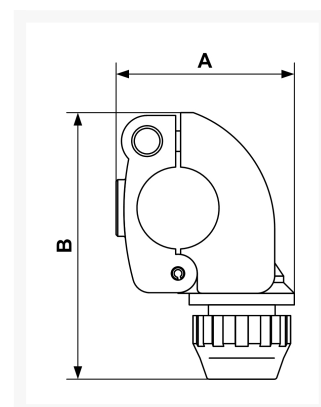

Aluminiowy kołnierz rozgałęzienia rury fi 63 x 25 mm

Product Images



Additional Information

Numer katalogowy	PPSBP6325
EAN	3660058243261
Waga (kg)	0.360000
Długość (mm)	142
Szerokość (mm)	115.5
Konstrukcja (materiał)	Aluminium
Średnica Ø (mm)	63 x 25
Ciśnienie maksymalne (bar)	13 w 40°C

