

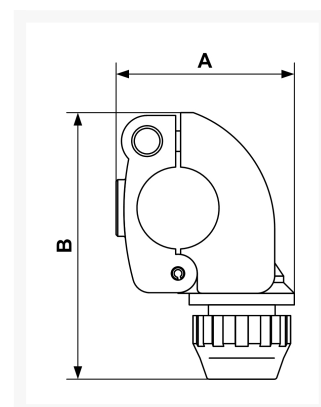

Aluminiowy kołnierz rozgałęzienia rury fi 25 x 20 mm

Product Images



Additional Information

Numer katalogowy	PPSBP2520
EAN	3660058243193
Waga (kg)	0.210000
Długość (mm)	104
Szerokość (mm)	69.5
Konstrukcja (materiał)	Aluminium
Średnica Ø (mm)	25 x 20
Ciśnienie maksymalne (bar)	13 w 40°C

