

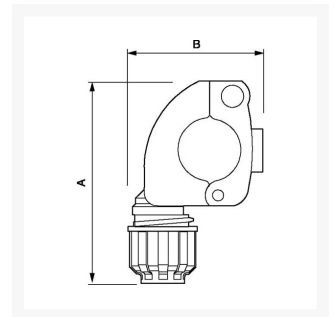

Kołnierz rozgałęzienia rury fi 50 x 20 mm

Product Images



Additional Information

Numer katalogowy	9ALRBP5020
EAN	3660058060677
Waga (kg)	0.400000
Długość (mm)	111
Wysokość (mm)	145
Konstrukcja (materiał)	Poliamid
Średnica Ø (mm)	50 x 20
Ciśnienie maksymalne (bar)	13 w 40°C

