



---

# Kołnierz rozgałęzienia rury fi 40 x 20 mm

## Product Images

---

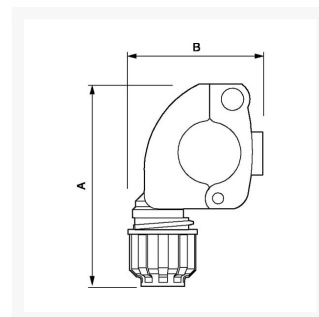

## Additional Information

---

Numer katalogowy	9ALRBP4020
EAN	8712418282443
Waga (kg)	0.268000
Długość (mm)	83
Wysokość (mm)	121
Konstrukcja (materiał)	Poliamid
Średnica Ø (mm)	40 x 20
Ciśnienie maksymalne (bar)	13 w 40°C

