

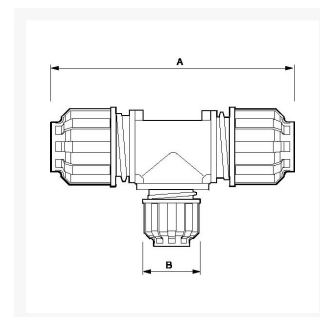

Trójnik redukcyjny fi 50 x 32 x 50 mm GW

Product Images



Additional Information

Numer katalogowy	9ALRTR5032
EAN	8712418403275
Waga (kg)	0.775000
Długość (mm)	205
Szerokość (mm)	65
Konstrukcja (materiał)	Poliamid
Średnica Ø (mm)	50 x 32 x 50
Ciśnienie maksymalne (bar)	13 w 40°C

