

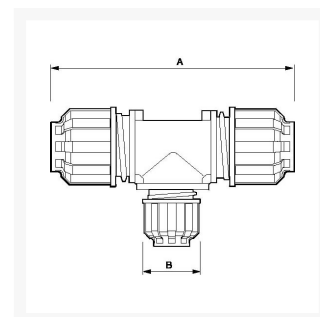

Trójnik redukcyjny fi 40 x 25 x 40 mm GW

Product Images



Additional Information

Numer katalogowy	9ALRTR4025
EAN	08712418282764
Waga (kg)	0.508000
Długość (mm)	182
Szerokość (mm)	52
Konstrukcja (materiał)	Poliamid
Średnica Ø (mm)	40 x 25 x 40
Ciśnienie maksymalne (bar)	13 w 40°C

