

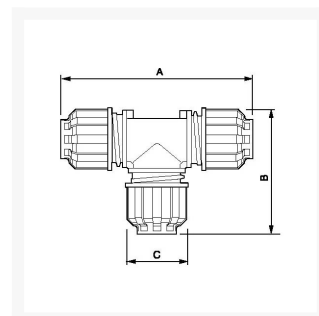

Trójnik fi 25 mm polimerowy

Product Images



Additional Information

Numer katalogowy	9ALRTE25
EAN	08712418282702
Waga (kg)	0.209000
Długość (mm)	132
Szerokość (mm)	53
Wysokość (mm)	88
Konstrukcja (materiał)	Poliamid
Średnica Ø (mm)	25
Ciśnienie maksymalne (bar)	13 w 40°C

