

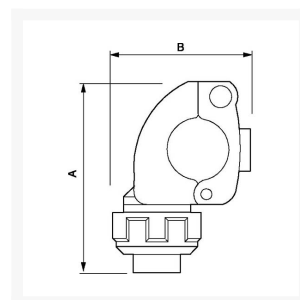

Kołnierz rozgałęzienia rur fi 50 mm x 1/2" GW

Product Images



Additional Information

Numer katalogowy	9AVRBT5012
EAN	3660058063944
Waga (kg)	0.420000
Wysokość (mm)	145
Konstrukcja (materiał)	Poliamid
Średnica Ø (mm)	50
Ciśnienie maksymalne (bar)	13 w 40°C
Rozmiar gwintu (")	1/2
Typ gwintu	Żeński

