

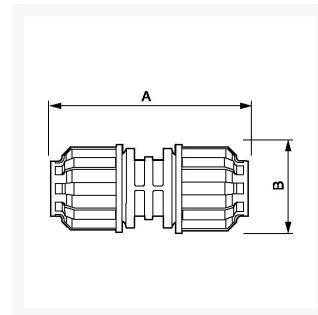

Złącze proste do rur fi 20 mm polimerowe

Product Images



Additional Information

Numer katalogowy	9ALRUN20
EAN	08712418282504
Waga (kg)	0.091000
Ciśnienie maksymalne (bar)	13 w 40°C

